

19" LED TV

Installation & Operating Instructions - Please keep for future reference

529/9122

BUSH

LED19982HDS



 **IMPORTANT** - Please read these instructions fully before installing or operating

These instructions contain important information which will help you get the best from your television and ensure safe and correct installation and operation.

For any help concerning set up and use of your TV please call the Customer Helpline: 0044 845 604 0105

Lines open: 9am - 8pm Monday to Saturday and 10am - 4pm Sunday

For any help concerning set up and use of your TV please call the Customer Helpline: 0044 845 604 0105

Issue 1 - 9/2/11

Contents

Contents	2	Connections	15
Contents	3	Back connections explained	15
Preparation	4	Left side connections explained	16
Intended Use	4	HDMI Connections	17
Power source	4	SCART Connections	17
Positioning the TV	4	VGA Connections	17
Power cord and plug	4	Side AV Connections	18
Moisture and Water	5	Using a Conditional Access Module	18
Ventilation	5	USB Connections	19
Heat sources and Flames	5	Basic Features	20
Headphone Volume	5	How to navigate menus - Selecting source	20
Wall Mounting (optional)	5	Electronic programme guide (EPG)	20
LCD Screen	5	General Operation	21
Cleaning	5	Displaying Subtitles	21
Batteries	5	Zoom Modes	21
Replacement Parts	6	Using Main Menu Screen	21
Servicing	6	Configuring Date/Time Settings	21
Taking out of service and storing	6	Source Settings	21
Connection to a Television Distribution System (Cable TV etc.) from Tuner	6	Audio Language	21
Symbols in this Instruction Book	6	Basic Features	22
Support	7	Navigating Channel List	22
TV - Features	8	Moving a Channel	22
Viewing remote control - TV	9	Deleting a Channel	22
Getting Started	10	Renaming a Channel	22
Attaching the Stand	10	Locking a Channel	22
Getting Started	11	Sorting Channel List	22
TV - Control buttons (left side)	11	Language Settings	24
Aerial connection	12	Language Settings	24
Power connection	12	Other Functions and Features	25
Remote control - Inserting batteries	12	Favourite Mode	25
Wall Mounting	12	Conditional Access	25
Switching the TV On and Off	12	Setting Sleep Timer	25
Switching the TV On	12	Setting Programme Timers	25
Switching the TV Off	12	Editing a Timer	25
Operation using TV control buttons	13	Deleting a Timer	25
Operation using Remote control buttons	13	Picture Controls	26
Initial set up	14	Configuring Picture Settings	26
General operation	14	Operating Picture Settings Menu Items	26
Information Banner	14	Picture Settings Menu Items	26
		PC Picture Settings Operation	26
		Sound and Source Settings	27
		Configuring Sound Settings	27
		Sound Settings Menu Items	27
		Configuring Source Settings	27
		Other Controls	28
		Operation	28
		Other Settings Menu Items	28

Contents

Advanced Features	29
Media Browser	29
Starting Media Browser	29
Media Browser Configuration	29
Operation	29
View Style	29
Slide Show Interval	29
Show Subtitle	29
Subtitle Language	29
Subtitle Position	29
Subtitle Font Size	29
Loop / Shuffle during Playback	29
Media Browser - continued	30
Viewing Videos via USB	30
Video Playback Screen	30
Subtitle Time Correction	30
Viewing Photos via USB	30
Displaying Photos in Slideshow Mode	30
Playing Music via USB	30
Setting the channels	31
Accessing Installation Menu	31
Automatic Channel Scan (Retune)	31
Manual Channel Scan	31
Analogue Fine Tune	31
First Time Installation	31
Clear Service List	31
Parental Control	32
Other Information	33
Teletext	33
Analogue Teletext	33
Digital Teletext (for the UK only)	33
Specifications	34
Other Information	35
Plug replacement - UK and Ireland only	35
Other Information	36
Product Support	37
Trouble shooting	37
Disposal information	38
Supported DVI Resolutions	38
Supported File Formats for USB Mode	39
AV and HDMI Signal Compatibility (Input Signal Types)	39
PC Input Typical Display Modes	40
Definition of important terms - TV	41
Software Upgrade	42
Guarantee	43

Model number

BUSH DVB-T LED19982HDS



Safety Information

Accessories Included

IMPORTANT - Please read these instructions fully before installing or operating



CAUTION
RISK OF ELECTRIC SHOCK
DO NOT OPEN



CAUTION: TO REDUCE THE RISK OF ELECTRIC SHOCK, DO NOT REMOVE COVER (OR BACK). NO USER-SERVICEABLE PARTS INSIDE. REFER SERVICING TO QUALIFIED SERVICE PERSONNEL.



The lightning flash with arrowhead symbol, within an equilateral triangle, is intended to alert the user to the presence of uninsulated "dangerous voltage" within the product's enclosure that may be of sufficient magnitude to constitute a risk of electric shock of persons.



The exclamation point within an equilateral triangle is intended to alert the user to the presence of important operating and maintenance (servicing) instructions in the literature accompanying the appliance.

Preparation

Place the device on a solid even surface. For ventilation, leave a free space of at least 10 cm all around the set. To prevent any fault and unsafe situations, do not place any objects on top of the set. Use this device in moderate climates.

Operation temperature and operation humidity: 5°C up to 45°C, 85% rel. humidity max. (not blocking ventilation openings).

Intended Use

This device is used to receive and display TV programmes. The different connection options make an additional expansion of the reception and display sources possible (various external devices). This device is only suitable for dry interior use. This appliance is intended solely for private domestic use and may not be used for industrial and commercial purposes. We exclude liability in principle, if the device is not used as intended, or unauthorized modifications have been made. To operate your LCD TV in extreme ambient conditions may cause the damage of the device.

⚠ WARNING: Never let people (including children) with physical, sensory or mental abilities or lack of experience and / or knowledge unsupervised use electrical device!

Children may not recognize dangers right! The swallowing of batteries can be fatal. Keep batteries always out of reach of small children. If a battery is swallowed, seek immediate medical attention. Keep the packaging films out of reach of children, there is a risk of suffocation.

Power source

- The TV should be operated only from a 220-240V AC, 50 Hz outlet.
- **⚠ Warning:** Do not leave your TV in standby or operating mode when you leave your house.

Positioning the TV

- For ventilation, please leave a clear space of at least 10cm all around the TV.
- **Do not** block the ventilation openings.
- **Do not** place the TV on sloping or unstable surfaces, the TV may tip over.
- To prevent damage to the TV, **do not** place any objects on top of the TV.
- Only use the TV in moderate climates.

Power cord and plug

- The power cord plug should be easily accessible. In case of storms and lightning, when going on holiday, or when the TV is not used for a long period of time disconnect the power cord from the mains power socket.
- The mains plug is used to disconnect TV set from the mains and therefore it must remain readily accessible.
- **Do not** place the TV, furniture, etc. on the power cord or pinch the cord.
- Handle the power cord by the plug, **do not** unplug the TV by pulling the power cord.
- Never touch the power cord/plug with wet hands as this could cause a short circuit or electric shock.
- Never make a knot in the power cord or tie it with other cords.
- Power cords should be placed in such a way that they are not likely to be stepped on or driven over.
- A damaged power cord/plug can cause fire or give you an electric shock. When damaged it must be replaced, this should only be done by qualified personnel.



Safety Information

Accessories Included

IMPORTANT - Please read these instructions fully before installing or operating

Moisture and Water

- **Do not** use this TV in a humid or damp place (avoid bathrooms, the sink in the kitchen, etc).
- **Do not** expose this TV to rain or water, as this may be dangerous.
- **Do not** place objects filled with liquids, such as flower vases, on top of the TV. Avoid from dripping or splashing.
- If any solid object or liquid falls into the cabinet, unplug the TV and have it checked by qualified personnel before operating it any further.

Ventilation

- The slots and openings on the TV set are intended for ventilation and to ensure reliable operation.
- To prevent overheating, these openings must not be blocked or covered in anyway.

Heat sources and Flames

- **Do not** expose the TV to direct sunlight or other heat sources.
- The TV should not be placed near to open flames and sources of intense heat such as an electric heater. 
- Ensure that no open flame sources, such as lighted candles, are placed on top of the TV.

Headphone Volume

- Excessive sound pressure from earphones and headphones can cause hearing loss, please take care. 

Wall Mounting (optional)

- To prevent injury, this TV must be securely attached to the wall in accordance with the installation instructions (if the option is available).



LCD Screen

- Occasionally, a few non-active pixels may appear on the screen as a fixed blue, green or red point. Please note that this does not affect the performance of your product.
- Take care not to scratch the screen with fingernails or other hard objects.

Cleaning

- Before cleaning, unplug the TV from the wall socket.
- **Do not** use liquid or aerosol cleaners. Only use a soft, dry cloth.

Batteries

- **Warning:** Incorrect installation of batteries may cause battery leakage and corrosion, resulting in damage to the remote control.  
- **Do not** mix old and new batteries, or batteries of different types.
- **Do not** dispose of batteries in a fire.
- **Do not** dispose of batteries with normal household waste, take to a local recycling centre.
- **CAUTION:** Insert the batteries / rechargeable batteries in the correct polarity. Don't try to recharge non rechargeable batteries and under no circumstances throw them into fire. Danger of explosion. Do not use unequal batteries (old and new, Alkaline and carbon, etc.) simultaneously. If you will not use the device for a long time, remove the batteries and store the device in a dry and dust free place. Improper use of batteries may cause an explosion or leakage. If the batteries have leaked, use gloves and clean the appliance thoroughly with a dry cloth! Batteries should not be exposed to heat, such as sunshine, fire or the like.



Safety Information

Accessories Included

 **IMPORTANT - Please read these instructions fully before installing or operating**

Replacement Parts

When replacement parts are required, make sure that the service technician has used replacement parts, which are specified by the manufacturer or have the same specifications as the original one. Unauthorised substitutions may result in fire, electrical shock or other hazards.

Servicing

-  **Warning:** Risk of electric shock, **do not** attempt to repair, service or modify this TV yourself. Contact the manufacturer, their approved service agent or the **Customer Helpline: 0845 604 0105**.

Taking out of service and storing

Unplug the TV from the mains and pack the TV in an appropriate cardboard box. Remove the batteries from the remote control and pack the remote control to the TV set.

 **NOTE:** The TV set should be stored in a dry and dust-free room.

Connection to a Television Distribution System (Cable TV etc.) from Tuner

Device connected to the protective earthing of the building installation through the mains connection or through other apparatus with a connection to protective earthing-and to a television distribution system using coaxial cable, may in some circumstances create a fire hazard.

Connection to a cable distribution system has therefore to be provided through a device providing electrical isolation below a certain frequency range (galvanic isolator, see EN 60728-11).

Symbols in this Instruction Book

The following symbols are used in the Instruction Book as a marker for restrictions and precautions and safety instructions. Note such information for security reasons.

WARNING

If you do not pay attention to such a marked warning, it can cause serious injury or death. Note these warnings strictly, in order to ensure a safe operation.

CAUTION

Such a precaution is marked, you should take up or note, to avoid injury or property damage. Note these instructions strictly, in order to ensure a safe operation.

IMPORTANT

Warnings on the appliance and restrictions are displayed like this. Read this information strictly in order to operate the system correctly and avoid damage.

 **NOTE:** Information about the operation and additional explanations are marked like this. To be aware of such information is recommended to ensure that the functions can be used optimally.

The Argos Technical Helpline is here to help

Technical experts are available 7 days a week

- **Simple help and advice on setting up your digital equipment (image).**
- **Guidance on connecting other devices to your television such as a DVD player, Sky, home cinema system or a games console.**
- **Order spare parts, including that lost remote control.**
- **Any other technical issues you may need assistance with.**

Call us today: 0044 845 604 0105

Local call rates applies*

Lines open 9am-8pm Monday to Saturday and 10am-4pm Sunday.

*Calls to Argos enquiry lines may attract a charge and set up fee from residential lines depending on your call plan/tariff. Mobile and other providers costs may vary, see www.bt.com/pricing for details.

For Security and training purposes, telephone calls to and from customer service centres maybe recorded and monitored. Calls from Republic of Ireland will attract international call charges.

Getting Started

TV - Features

- Remote controlled colour LCD TV.
- Fully integrated Terrestrial digital TV, (MPEG4)
- HDMI connectors for digital video and audio.
This connection is also designed to accept high definition signals.
- USB input.
- 1000 programmes (analogue+digital).
- OSD menu system.
- Integrated tuner, MPEG 4 compatible.
- Scart socket for external devices (such as video, video games, audio set, etc.).
- Stereo sound system. (German+Nicam)
- Teletext, fastext, TOP text.
- Headphone connection.
- Automatic programming system.
- Forward or backward manual tuning.
- Sleep timer / Child lock.
- Automatic sound mute when no transmission.
- NTSC playback.
- AVL (Automatic Volume Limiting).
- Auto power down.
- PLL (Frequency Search).
- PC input.
- Plug&Play for Windows 98, ME, 2000, XP, Vista, Windos 7.
- Game Mode

Accessories included

Remote Control
Batteries: 2 x AAA
Instruction Book
Quick Start Guide
Side AV Connection Cable

Optional Accessories

Wall mount bracket

 **NOTE:** You should check the accessories after purchasing. Make sure that each accessory is included.

Getting Started - TV

Viewing remote control - TV

1. Standby
2. Mono/Stereo - Dual I-II / Current Language (in DVB channels)
3. Image size
4. Green button
5. Red button
6. Numeric buttons
7. Teletext / Mix(in TXT mode)
8. Cursor Left
9. Menu on-off
10. AV / Source selection
11. Favourite Mode Selection(in DVB channels)
12. Volume Up
13. Info / Reveal (in TXT mode)
14. Mute
15. Volume Down
16. Programme Down / Page up(in DVB channels)
17. Electronic programme guide(in DVB channels)
18. Programme Up / Page down(in DVB channels)
19. Sleep Timer
20. Picture mode selection
21. Okay (Confirm) / Hold (in TXT mode)/ Edit Channel List
22. Cursor Down
23. Exit / Return / Index page (in TXT mode)
24. Cursor Right / Subpage (in TXT mode)
25. Cursor Up
26. Previous programme
27. Yellow button
28. Blue button
29. No function
30. Subtitle on-off (in DVB channels)

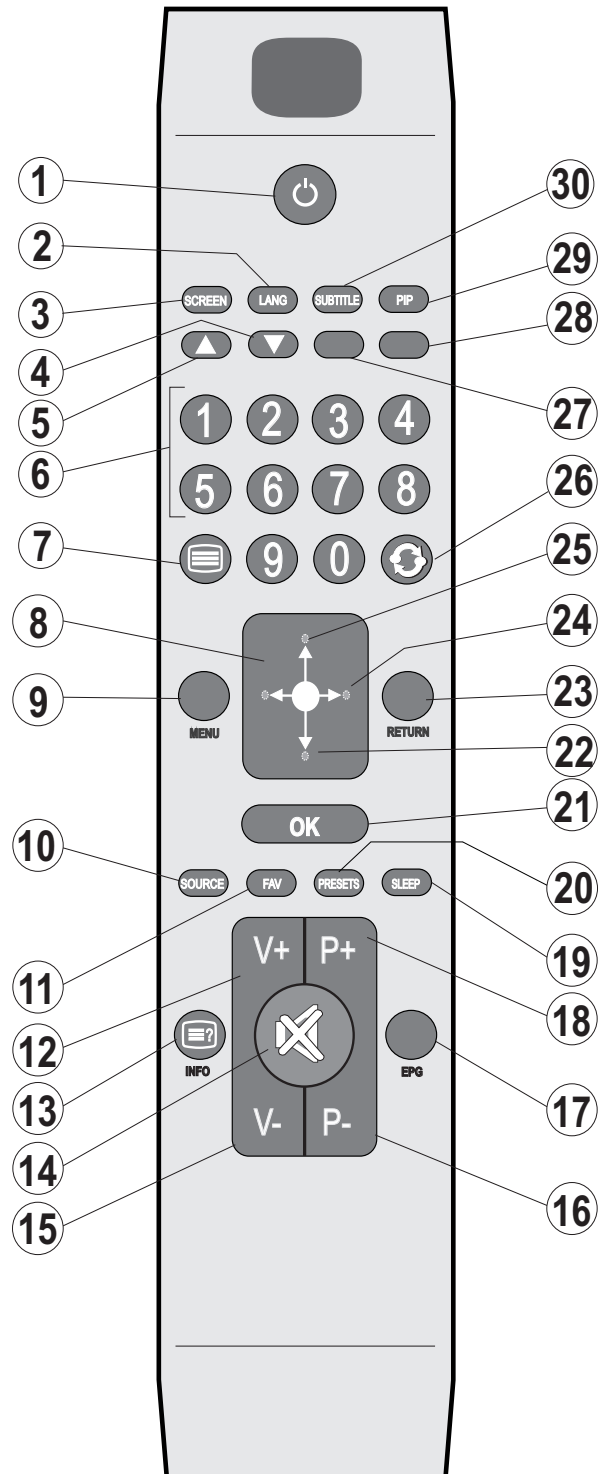

Getting Started

Attaching the Stand

1. Stand is placed on a flat surface (fig.1).

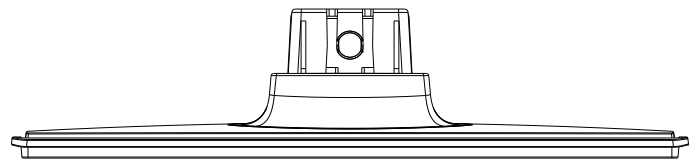

fig.1

2. The product is held over the stand so that it coincides with the stand mounting point and then it is left to be mounted with its own weight (fig.2).

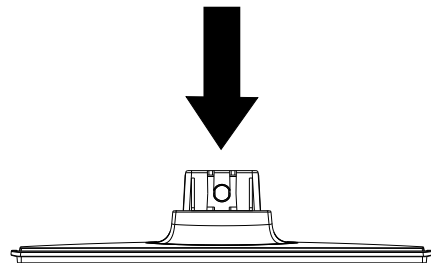
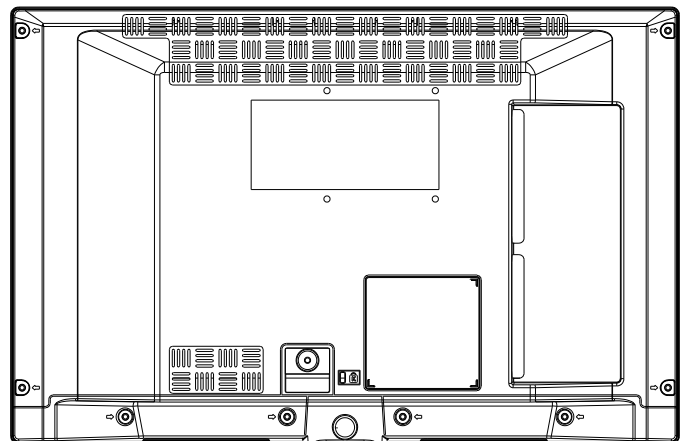

fig.2

Getting Started

TV - Control buttons

1. Up direction
2. Down direction
3. Programme/Volume / AV / Standby-On selection switch

The Control switch allows you to control the Volume/ Programme/ Source and Standby-On functions of the TV.

To change volume: Increase the volume by pushing the button up. Decrease the volume by pushing the button down.

To change channel: Press the middle of the button, the channel information banner will appear on screen. Scroll through the stored channels by pushing the button up or down

To change source: Press the middle of the button twice, the source list will appear on screen. Scroll through the available sources by pushing the button up or down.

To turn the TV off: Press the middle of the button down and hold it down for a few seconds, the TV will turn into standby mode.

 **NOTE:** You can move the switch, upward or downward to change the volume. If you want to change the channel, press the middle of the switch once (Position 3) and then move upward or downward. If you press the middle of the switch once more, the source OSD will be displayed. To select desired source, move the switch upward or downward and release. If you press the middle of the switch and hold for a few seconds, the TV will switch to standby mode. The Main menu OSD cannot be displayed via the control buttons on the TV.

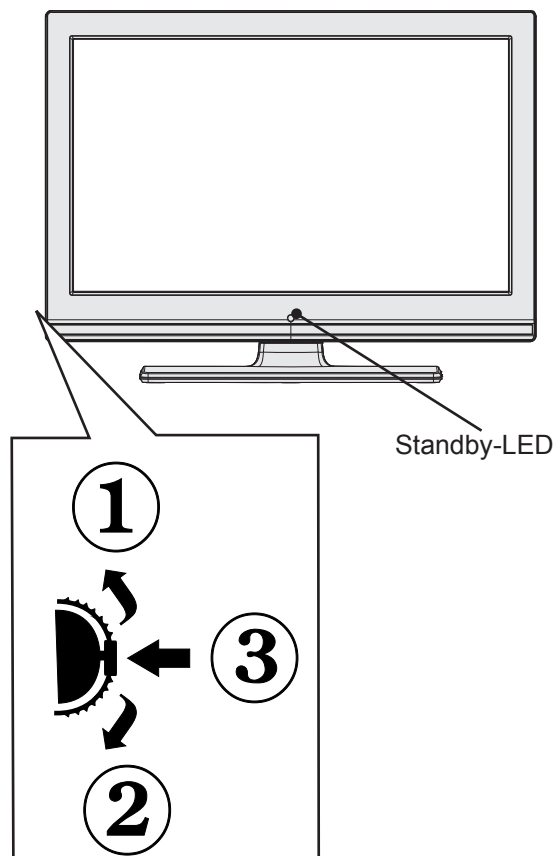

Getting Started

Aerial connection

Connect the “aerial” or “cable TV” plug to AERIAL INPUT (**ANT.**) socket located on the back of the TV (fig.1).

Power connection

IMPORTANT :The TV set is designed to operate on 220-240V AC, 50 Hz.

Please note: After unpacking, allow the TV to reach ambient room temperature before connecting the TV to the mains power socket.

Connect the power cord plug to the mains power socket.

The LED on the front of the TV then lights up, this indicates that the TV is in ‘Standby’ mode.

Remote control - Inserting batteries

Remove the battery cover on the back of the remote control, gently push down and pull backwards at the same time as shown.

Insert two **AAA/R3** or equivalent type batteries. Ensure the batteries are inserted the correct way and replace the battery cover (fig.2).

NOTE: When the remote control is not going to be used for long periods of time, the batteries should be removed. Otherwise the remote control may be damaged, caused by battery leakage and corrosion.

Wall Mounting

When wall mounting please ensure you use a compatible wall mount (not supplied). This TV conforms to the VESA mounting specifications and is 75 x 75 mm.

Switching the TV On and Off

Switching the TV On

With power cord plug connected to the mains power socket, the TV is in ‘Standby’ mode.

To switch the TV on from standby mode:

Press the “” button and the TV will switch to standby mode. Then the standby LED lights up.

To switch on the TV from standby mode either:

a. Press the “” button, P+ / P- or a numeric button on the remote control.

b. Press the middle of the “” button on the TV..

By either method the TV will switch on.

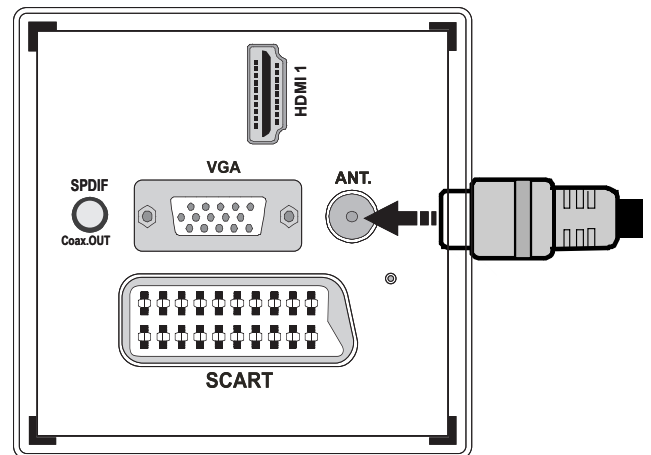
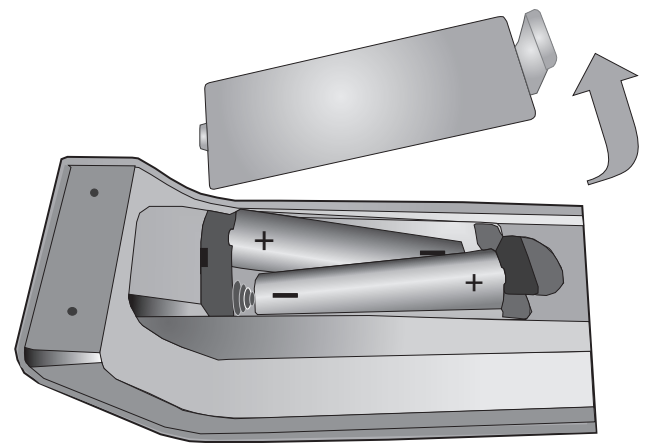



fig.1



AAA/R3 x 2
Batteries

fig.2

Switching the TV Off

Press the “” button on the remote control or press the standby “” button, so the TV will switch to standby mode.

To turn off the TV completely, remove the power cord plug from the mains power socket.

NOTE: When the TV is in standby mode, the standby LED can blink to indicate that features such as Standby Search, Over Air Download or Timer is active.

NOTE: If you switch on your TV via P +/- buttons on the remote control or +/- on the TV set, the programme that you were watching last will be reselected.

Getting Started

Operation using TV control buttons

The main menu OSD (On Screen Display) cannot be displayed using the TV control buttons.

The Control switch allows you to control the Volume/ Programme/ Source and Standby-On functions of the TV.

To change volume: Increase the volume by pushing the button up. Decrease the volume by pushing the button down.

To change channel: Press the middle of the button, the channel information banner will appear on screen. Scroll through the stored channels by pushing the button up or down

To change source: Press the middle of the button twice, the source list will appear on screen. Scroll through the available sources by pushing the button up or down.

To turn the TV off: Press the middle of the button down and hold it down for a few seconds, the TV will turn into standby mode.

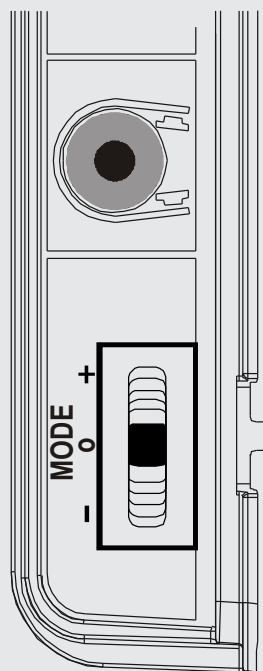

Operation using Remote control buttons

The remote control is designed to control all the functions of the model you selected.

Volume Setting

Press “V +” button to increase the volume. Press “V -” button to decrease the volume. A volume level scale (slider) will be displayed on the screen.

Programme Selection (Previous or Next Programme)

Press **P-** button to select the previous programme. Press **P+** button to select the next programme.

Programme Selection (Direct Access)

Press number buttons on the remote control to select programmes between 0 and 9. The TV will switch to the selected programme.

To select programmes between 10-500 (IDTV) or 10-199 (analogue), press the number buttons consecutively.

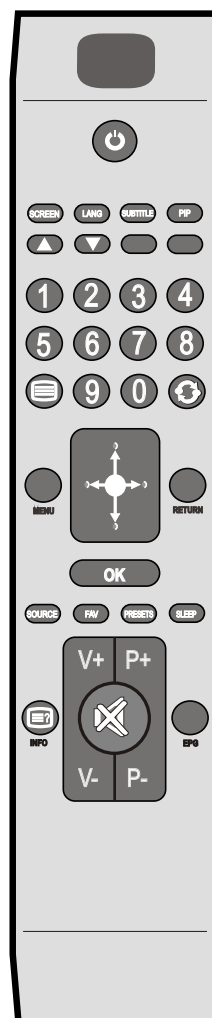

Getting Started

Initial set up

When turned on for the first time, language selection message is displayed (fig.1). Press the “^” or “v” button to highlight the required language, press **OK** button to select. “First Time Installation” appears. Use “<” or “>” button to set the required country, and press “v” button to select “Teletext Language”. Use “<” or “>” button to set the “Teletext Language” and select “Scan Encrypted” using “^” or “v” button. Set “Scan Encrypted” using “<” or “>” button (fig.2).

Press **OK** button on the remote control to continue and the confirmation screen will be displayed on the screen (fig.3). To start automatic select **Yes** (to cancel select **No**), highlight the item required using the “<” or “>” button and press **OK** button to select. The search will start (fig.4).



IMPORTANT: Do not turn off the TV while “First Time Installation” is in operation.

After all the available stations are stored, Channel List will be displayed on the screen. If **LCN (*)** is available in your country, a message appears on the screen which asks you if you want to sort the channels according to LCN. In some countries, the order of the channels is arranged automatically by the broadcaster. This is called logical channel number (LCN). If the selected country has LCN support, the channels will be enumerated one by one, beginning from number 1. You cannot move any programme to a position after the last saved one. If you try to do this, both programmes will change their places. If LCN support is not available, you can move the channels as you wish.

Press **OK** button to quit channel list and watch TV.

(*) LCN is the Logical Channel Number system that organizes available broadcasts in accordance with a recognizable channel sequence.

Source Selection

Press the **SOURCE** button on the remote control for switching between the sources.

Information Banner

Whenever you change channel using the **P-/P+** buttons or the numeric buttons, the TV displays the broadcast picture along with an information banner at the bottom of the screen. The information banner can be displayed at any time while watching TV by pressing the **INFO** button on the remote control (fig.5).

Hint: Not all channels broadcast the programme data. If the name and time of the programme are not available, then information banner will be displayed with blanks.

If the selected channel is locked, you must enter the correct four-digit numeric code to view the channel (default code is **0000**). “Enter PIN” will be displayed on the screen in such a case.

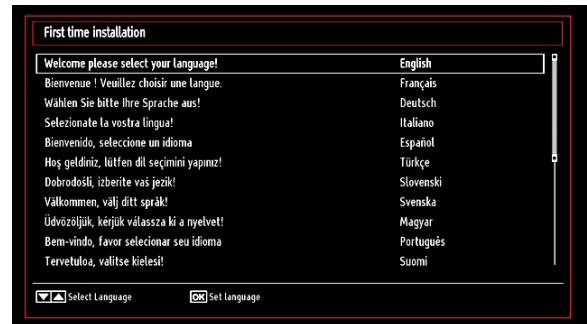

(fig.1)

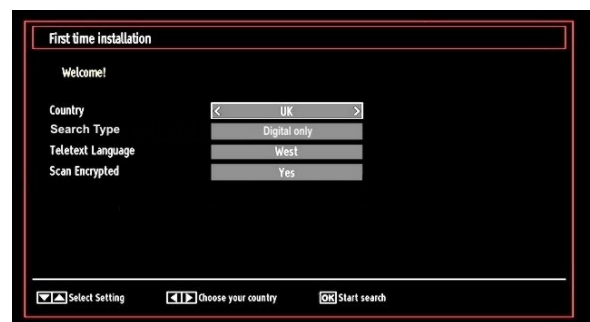

(fig.2)

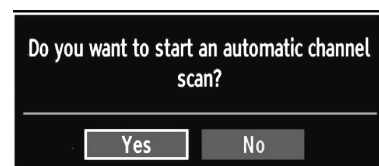

(fig.3)



(fig.4)



(fig.5)

Connections

Back connections explained

1. SCART socket

Inputs or outputs for external devices. Connect the SCART cable between the SCART socket on the TV and the SCART socket on the external device (decoder, VCR or DVD player) (see page 00).

NOTE: If an external device is connected via the SCART socket, the TV will automatically switch to AV mode. When receiving DTV channels (Mpeg4 H.264) or while in Media Browser mode, output will not be available via the scart socket.

2. HDMI Inputs

Connects a device that has an HDMI socket. The TV can display High Definition pictures from devices such as a High Definition Satellite Receiver or DVD Player. These devices must be connected via the HDMI sockets or Component Socket. No sound connection is needed for an HDMI to HDMI connection (see page 00).

3. PC Input (VGA)

Connects a personal computer to the TV. Connect the PC cable between the PC INPUT on the TV and the PC output on the PC. You can use the PC input to allow YPbPr signal connection with a device that has component output. Connect the YPbPr to PC cable (not supplied) between the PC INPUT on the TV and the component video outputs of the device.

4. RF Input (ANT.)

Connects to aerial (antenna) or cable TV. If you use a decoder or a media recorder, you should connect the aerial cable through the device to the TV with an appropriate aerial cable (see page 00).

NOTE: When using the wall mounting kit (optional), we recommend that you plug all your cables into the back of the TV before mounting on the wall.

5. S/PDIF Coaxial Out

Outputs digital audio signals of the currently watched source.

Use an SPDIF coaxial cable to transfer audio signals to a device that has S/PDIF input.

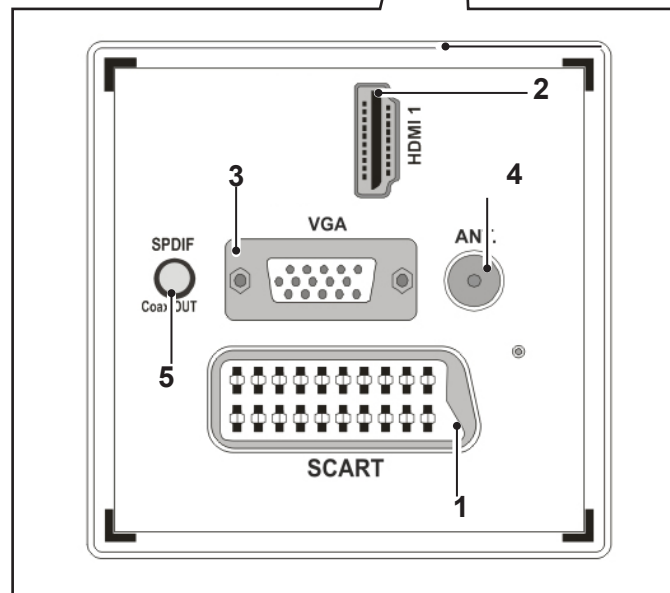
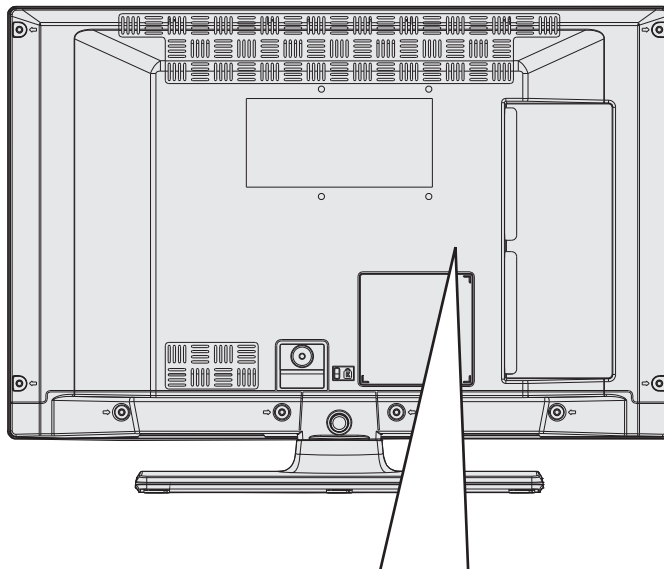

Connections

Left side connections explained

6. CI Slot

Used to insert a CI card. A CI card allows you to view all the channels that you subscribe to. For more information, see “Conditional Access” section.

7. USB Input

To connect devices to the TV, providing fast data exchange. USB will only function in DTV mode.

Use an SPDIF coaxial cable to transfer audio signals to a device that has S/PDIF input.

8. Side audio-video input

This input is used for connecting video and audio signals of external devices. To make a video connection, you must use the supplied AV connection cable for enabling connection. First, plug singular jack of the cable to the TV's Side AV socket. Afterwards, insert your video cable (not supplied) connector into the YELLOW input (located on the side with several connectors) of the supplied AV connection cable. Colours of the connected jacks should match. To enable audio connection, you must use RED and WHITE inputs of the side AV connection cable. Afterwards, insert your device's audio cable connectors into the RED and WHITE jack of the supplied side AV connection cable. Colours of the connected jacks should match.

NOTE: You should use audio inputs of side AV connection cable (RED & WHITE) to enable sound connection when connecting a device to your TV by using a VGA connection (You need a VGA to YPbPr cable, not supplied).

9. Headphone

Headphone jack is used for connecting an external headphone to the system. Connect to the HEADPHONE jack to listen to the TV from headphones (optional).

10. Magic Button

Volume/ Programme/ Source and Standby-On switch.

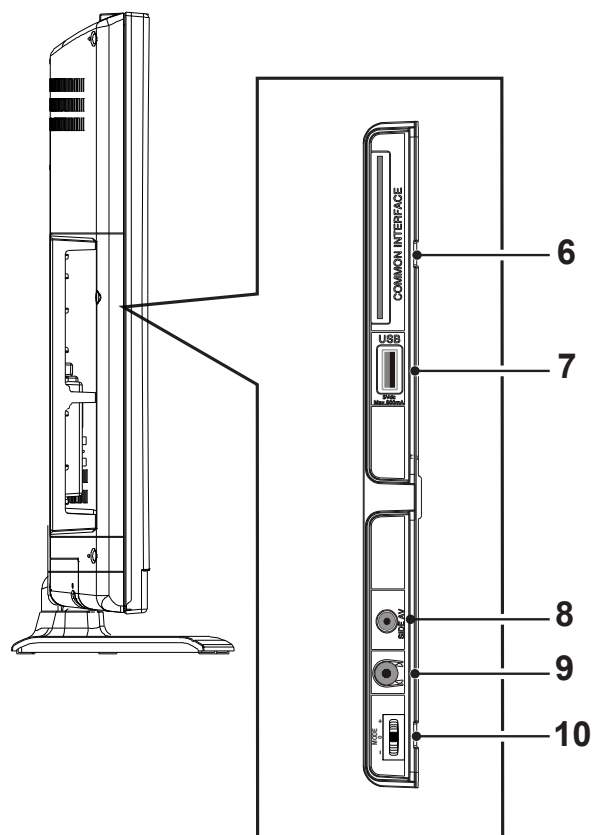

Connections

HDMI Connections

HDMI lets you enjoy high definition digital images and high quality sound by connecting the TV to external devices such as DVD players, set top boxes or gaming equipment (fig.1).

Power off both the TV and the device before making any connections.

For more information, refer to your device's own instruction book.

After making the connection, switch to HDMI 1 or HDMI2 as a source, depending on which HDMI connector the external equipment is connected. See, **Input Selection** section for more information on changing sources.

NOTE: HDMI cable is not supplied.

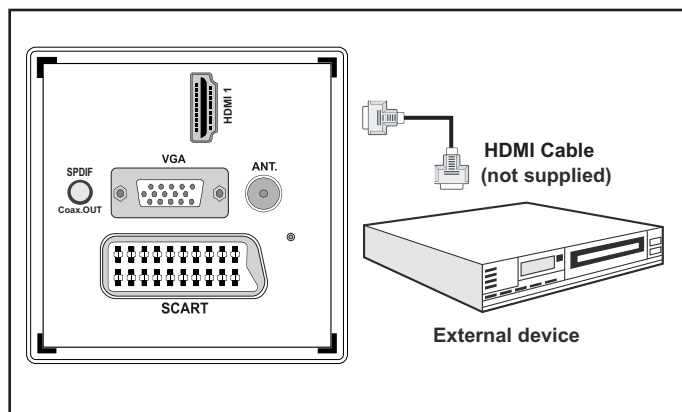

fig.1

SCART Connections

Most devices support SCART connection. You can connect a DVD recorder, VCR or decoder to the TV using the SCART socket (fig.2).

Power off both the TV and the device before making any connections.

For more information, refer to your device's own instruction book.

NOTE: The Scart cable is not supplied.

NOTE: If your external device has a **S-Video output**, it is possible to connect your external device with a **SCART-S-video adapter** (not included) to the scart input of the TV. First plug the SCART S-Video adapter to the SCART connector on your TV set. Then, connect a S-video cable to the SCART socket (via the Scart S-Video adapter) to the S-video output of your external device.

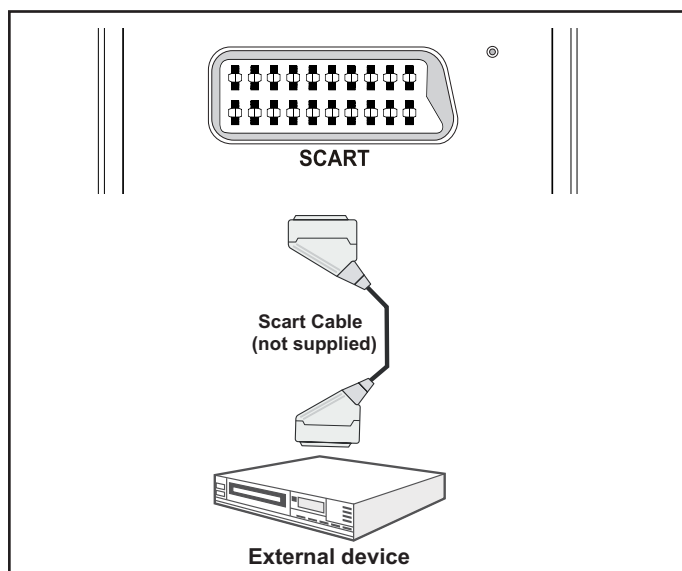

fig. 2

VGA Connections

You can connect a computer (PC) to the TV to display your computer's screen image on the TV. Power up both computer and TV before making any connections.

Use a 15-pin D-sub display cable to connect a PC to the TV. Use an audio cable between audio inputs on the left side of the TV and audio output on your PC to enable sound connection (fig.3). You will need to use the supplied SIDE AV CONNECTION cable for connecting audio signals.

When the connection is made, switch "Source" to "PC-VGA". See "Input selection" section.

Set the resolution that suits your viewing requirements. Resolution information can be found in the "Appendix parts" .

NOTE: The cable is not supplied.

NOTE: You can use YPbPr to VGA cable (not supplied) to enable YPbPr signal via VGA input.

WARNING: You cannot use VGA and YPbPr at the same time.

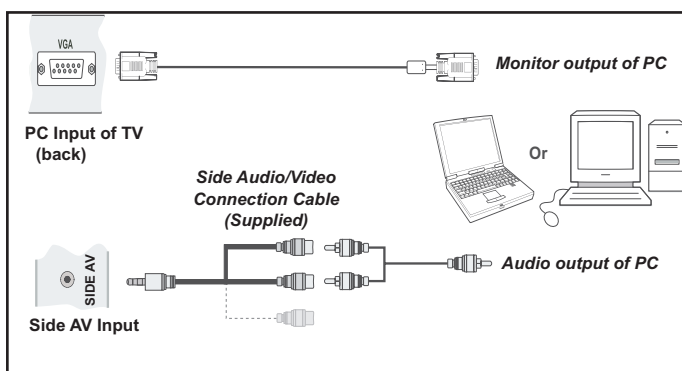

fig. 3

Connections

Side AV Connections

You must use the supplied SIDE AV connection cable for enabling SIDE AV connection.

1. Plug single jack of the cable to the TV's SIDE AV socket.
2. Insert your AV cable's (not supplied) connectors into the plural part of the SIDE AV connection cable (see illustration below). Colours of the connected jacks should match.
3. To enable audio connection, use an audio cable. Insert your device's audio cable's connectors into the plural part of the **SIDE AV connection cable**. Colours of the connected jacks should match (fig.1).
4. When the connection is made, switch to **SIDE AV** source.

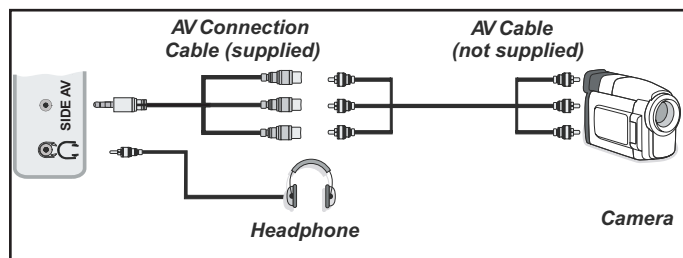

fig. 1

Using a Conditional Access Module

IMPORTANT: Insert or remove the CI module only when the TV is SWITCHED OFF.

In order to watch certain digital channels, a conditional access module (CAM) can be necessary. This module must be inserted in the CI slot of your TV.

1. Obtain the Conditional Access Module (CAM) and the viewing card by subscribing to a pay channel company, then insert those to the TV using the following procedure.
 2. Insert the CAM and then the viewing card to the slot that is located in the terminal cover at the rear side of the TV.
 3. The CAM should be correctly inserted, it is impossible to insert fully if reversed. The CAM or the TV terminal may be damaged if the CAM is forcefully inserted.
 4. Connect the TV to the mains supply, switch on and then wait for few moments until the card is activated.
 5. When no module is inserted, "**No Common Interface module detected**" message appears on the screen.
- You can refer to the module instruction manual for details of the settings.

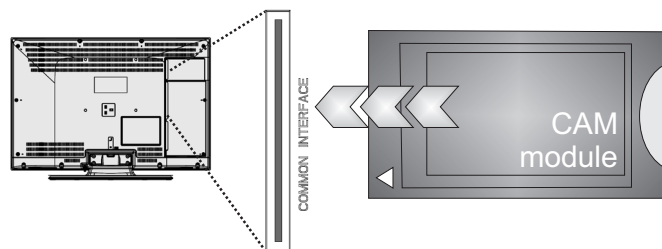

fig. 2

Connections

USB Connections

2.5" and 3.5" inch (hdd with external power supply) external hard disk drives are supported.

IMPORTANT

You should back up your files before making any connections to the TV set in order to avoid any possible data loss. Note that manufacturer will not be responsible for any file damage or dataloss.

It is possible that certain types of USB devices (e.g. MP3 Players) or USB hard disk drives/memory sticks may not be compatible with this TV.

The TV supports FAT32 and NTFS disk formatting.

USB Disk Connection

Plug your USB device to the USB input of the TV.

NOTE:

Plug or unplug your USB disk while the TV is switched off.

If you are going to connect a USB hard disk drive to the TV set, USB connection cable used between the disk drive and the TV should have a USB logo and should be as short as possible.

While formatting a USB hard disk that has 1TB (Tera Byte) or more file capacity, you can experience problems with the formatting process. In such a case, you should format the disk with your personal computer and the formatted disk type should be FAT32.

CAUTION:

Quickly plugging and unplugging USB devices, is a very hazardous operation. Especially, do not repeatedly quickly plug and unplug the drive. This may cause physical damage to the USB player and especially the USB device itself. Do not pull out USB module while playing or recording a file.

Basic Features

How to navigate menus - Selecting source

Once you have connected external devices to the TV, you can select and change the input source required.

To change Input Selection, use one of the following options:

Option a: Press the **SOURCE** button on the remote control to directly select required source.

Option b: Select **"SOURCES"** from the **"Settings"** menu using the **"^"** or **"v"** button.

Use the **"^"** or **"v"** button to highlight the required input and press the **">"** button to select.

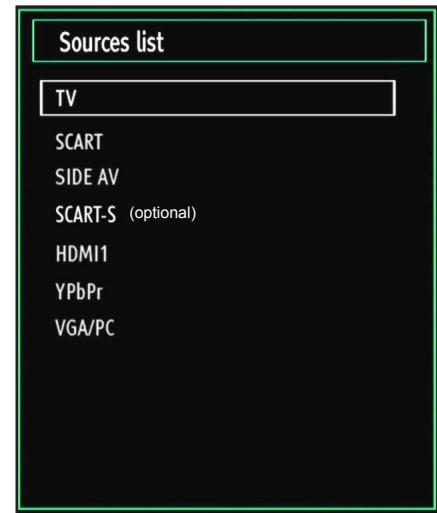

Electronic programme guide (EPG)

Some, but not all channels send information about the current and next programmes. Press the EPG button to view the EPG menu.

It is able to get Information on all programmes for the next 7 days by means of the 7-DAY-EPG. All programmes on each channel will be displayed.

Info bar commands:

RED button - Shrink: reduces info boxes.

GREEN button - Expand: enlarges info boxes.

YELLOW button - Prev. day: displays programmes from previous day.

BLUE button - Next day: displays programmes for next day (will move forward a day each time button is pressed).

INFO button - Details: displays, in detail information on programme selected.

OK button - Reminder: to view current selected broadcasts or set reminders for future programmes.

Number buttons - Jump: go to preferred channel directly using number buttons.

0 button - Search: to view "Guide Search" menu. Using this feature, you can search the programme guide database in line with the genre selected or with name match and on the day/s selected.

☺ button - Now: jumps to the current broadcast (when viewing previous "Prev. day" or future "Next day" programmes).



EPG screen in regular mode

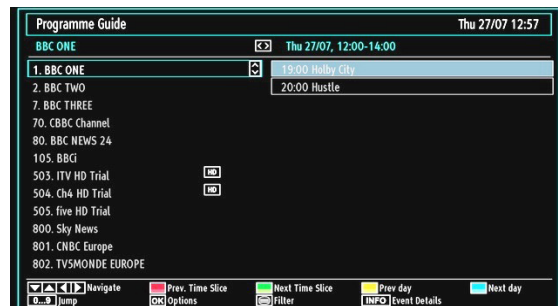

EPG screen in programme schedule



EPG screen in timeline schedule

Basic Features

General Operation

Displaying Subtitles

With digital terrestrial broadcasting (DVB-T), some programmes are broadcasted with subtitles.

1. Press **MENU** button to display main menu, highlight "**Settings**" then "**Language Settings**" menu using "**<**" or "**>**" or "**^**" or "**v**" button, press **OK** button to display "Language settings" menu.

2. Highlight "**Subtitle**" in "**Language settings**" menu using "**^**" or "**v**" button. Use "**<**" or "**>**" button to set Subtitles to the desired language.

 **NOTE:** You can directly press **SUBTITLE** button do enable or disable subtitles.

Zoom Modes

Programmes can be watched in different picture formats, depending on the transmission received.

You can change the aspect ratio (image size) of the TV for viewing the picture in different zoom modes.

Press **SCREEN** button repeatedly to change the image size. Available zoom modes are; Auto, 16:9, Subtitle, 14:9, 14:9 Zoom, 4:3, Panoramic and Cinema.

 **NOTE:** You can shift the screen up or down by pressing "**v**" / "**^**" buttons while picture zoom is selected as panoramic, 14:9 Zoom, Cinema or Subtitle. This is only possible as long as the display of the screen format is displayed.

Using Main Menu Screen

1. Press **MENU** button to display main menu, highlight the desired control icon using "**<**" or "**>**" or "**^**" or "**v**" button, press **OK** button to display menu contents.
2. Highlight an option inside a menu screen by using "**^**" or "**v**" button.
3. Use "**<**" or "**>**" button to set an option.
4. If "**OK**" box is displayed next to a menu setting, press "**OK**" to display sub-menu screen.

Changes are automatically stored. Press "**MENU**" to exit.

 **NOTE:** See **Picture, Sound, Settings and Installation Control** sections on pages 16-18 for learning the functions of menu items.

Configuring Date/Time Settings

1. Select **Date/Time** in the Settings menu to configure Date/Time settings.
2. Press **OK** button.

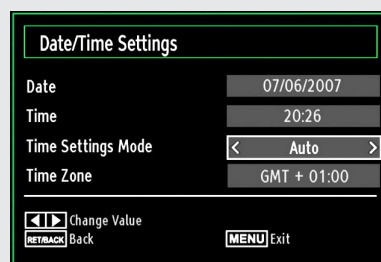

3. Use "**^**", "**v**" and "**<**", "**>**" buttons to set the options. Some items might be available to be set due to the selected modes.

Source Settings

You can enable or disable selected source options. When set, the TV will not switch to the disabled source options when "**SOURCE**" button is pressed.

1. Select "Sources" in the "Settings" menu and press "**OK**" button.
2. Press "**^**", "**v**" buttons to select a source.
3. Use "**<**", "**>**" button to enable or disable the selected source.

Audio Language

If there is a programme that is broadcasted with multi-channel sound and offers different languages, you can choose the audio language. Press **LANG.** button to select between available options.

Basic Features

Channel management

The TV sorts all stored stations in the Channel List. You can edit this channel list, set favourites or set active stations to be listed by using the Channel List options.

Press **MENU** button to view main menu. Select Channel List item by using “<” or “>” button. Press **OK** to view menu contents.



Select **Edit Channel List** to manage all stored channels. Use “^” or “v” and **OK** buttons to select “**Edit Channel List**”.

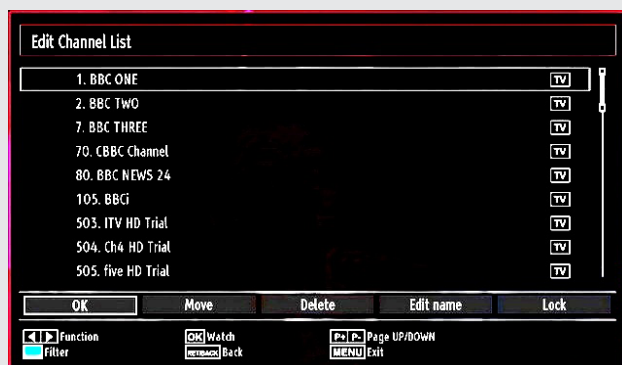

Navigating Channel List

1. Press “^” or “v” button to select previous or next channel. Press **P+** or **P-** button to move up or down the page.
2. To watch a specific channel, highlight the “**OK**” box on Channel List menu using “<” or “>” button.

Filtering Options

Press **BLUE** button to view filtering options. You can filter channels by **Digital Aerial/Analog**, **TV/Radio**, **Free/CAS***, **A-Z** or **Sort** from channel list filter menu (*CAS=encrypted channels).

Moving a Channel

1. Select the desired channel.
2. Select **Move** box in the channel list and press **OK** button.
3. **Edit Number** screen will be displayed. Enter the desired channel number by using the numeric buttons on the remote control.

Note: If there is a previously stored channel on that number, a warning screen will be displayed.

4. Select **Yes** if you want to move the channel and press **OK**.

Deleting a Channel

1. Select the channel that you want to delete and select **Delete** box.
2. Press **OK** button to continue. A warning screen will appear. Select **YES** to delete, select **No** to cancel. Press **OK** button to continue.

Renaming a Channel

1. Select the channel that you want to rename and select **Edit Name** box. Press **OK** button to continue.
2. Use navigation buttons to toggle between the current character, i.e., ‘b’ character becomes ‘a’ by “v” and ‘c’ by “^”.
3. When finished, press **OK** button to save. Press **MENU** to cancel.

Locking a Channel

1. Select the channel that you want to lock and select **Lock** option. Press **OK** button to continue.
2. You will be asked to enter parental control PIN. Default PIN is set as **0000**. Enter the PIN number.
3. The desired channel is locked (Lock symbol is displayed next to the selected channel) or unlocked.

Sorting Channel List

You can select broadcasts to be listed in the channel list. To display specific types of broadcast, you should use Active channel list setting.

Select Active channel list from the Channel list menu by using “^” or “v” button. Press **OK** button to continue.

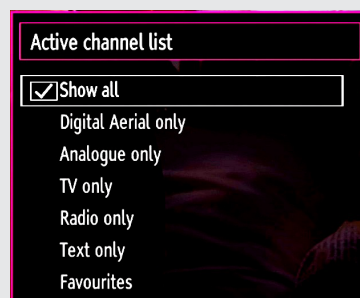

You can select a broadcast type option from the list by using “^” or “v” and **OK** buttons.

Basic Features

Environmental Information

This television is designed to consume less energy to save environment.

You not only help to save the environment but also you can save money by reducing electricity bills thanks to the energy efficiency feature of this TV. To reduce energy consumption, you should take the following steps:

You can use Power Save Mode setting, located in the Other Settings menu. If you set Power Save Mode as On, the TV will switch to energy-saving mode and luminance level of TV set will be decreased to optimum level. Note that some picture settings will be unavailable to be changed when the TV is in Power Save Mode.

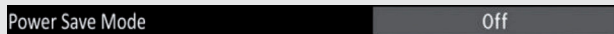

When the TV is not in use, please switch off or disconnect the TV from the mains plug. This will also reduce energy consumption.

Disconnect power when going away for longer time.

Note that annually, using the TV set in Power Save Mode has more power efficiency than disconnecting the TV from the mains plug instead of keeping stand-by mode. Therefore it is highly recommended to activate Power Save Mode setting to reduce your annual power consumption. And also it is recommended to disconnect the TV from the mains plug to save energy more when you do not use.

Please helps us to save environment by following these steps.

Repair Information

Please refer all servicing to qualified personnel. Only qualified personnel must repair the TV. Please contact your local dealer, where you have purchased this TV for further information.

Basic Features

Language Settings

You can operate the TV's language settings using this menu.

Press **"MENU"** button and select the Settings icon by using "**<**" or "**>**" button. Press **OK** button to view Settings menu. Use "**^**" or "**v**" button to highlight **Language** and press **OK** to continue:

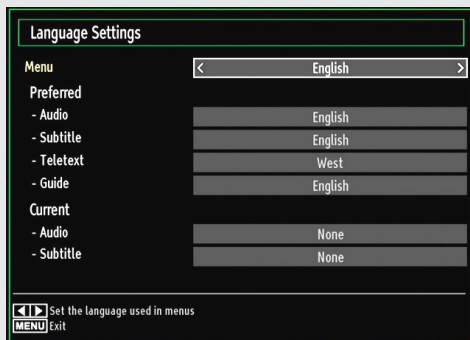

Use "**v**" or "**^**" button to set an item. Settings are stored automatically.

Menu: displays the system language.

Preferred

These settings will be used if available. Otherwise the current settings will be used.

Audio: Sets the preferred audio language.

Subtitle: Sets the subtitle language. Selected language will be seen in subtitles.

Teletext: Sets teletext language.

Guide: Sets the preferred Guide language.

Current (*)

() These settings can be changed if only the broadcaster supports. Otherwise, settings will not be available to be changed.*

Audio: Changes the audio language for the current channel.

Subtitle: Sets the subtitle language for the current channel.

NOTE: If the Country option is set to Denmark, Sweden, Norway or Finland, the Language Settings menu will function as described below:

Language Settings

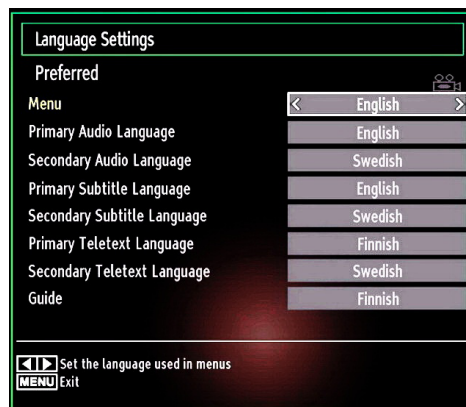

In the configuration menu, highlight the Language Settings item by pressing "**^**" or "**v**" buttons. Press **OK** and Language Settings submenu will be displayed on the screen:

Use "**^**" or "**v**" buttons to highlight the menu item that will be adjusted and then press "**<**" or "**>**" button to set.

NOTE:

System Language determines the on-screen menu language.

Audio Language is used for selecting the soundtrack of a channels.

Primary settings are the first priority when multiple choices are available on a broadcast. Secondary settings are the alternatives when the first options are not available.

Basic Features

Other Functions and Features

Favourite Mode

You can create a list of favourite programmes using the favourites feature. In such a case, only the favourite channels are navigated.

1. Press “**MENU**” button to view main menu.
2. Select Channel List item by using “**<**” or “**>**” button.
3. Press “**OK**” to view menu contents.
4. Use “**^**” or “**v**” and “**OK**” buttons to select “Favourites”.



5. Select a channel by using “**^**” or “**v**” button.
6. Press “**OK**” button to add selected channel to favourites list. Press “**OK**” button again to remove.

Button Functions

OK: Add/remove a station.

YELLOW: Tag/untag a channel.

GREEN: Tag/untag all channels.

BLUE: Displays filtering options.

Conditional Access

If you have inserted a conditional access module and viewing card to your TV, you can use Conditional Access menu. Note that these menu settings may change depending on the service provider.

1. Press “**MENU**” button and select the “Settings” icon by using “**<**” or “**>**” button.
2. Press “**OK**” button to view Settings menu.
3. Use “**^**” or “**v**” button to highlight **Conditional Access** and press “**OK**” to view menu items.

Setting Sleep Timer

This setting is used for setting the TV to turn off after a certain time.

1. Press “**MENU**” button and select the “Settings” icon by using “**<**” or “**>**” button.
2. Press “**OK**” button to view Timers menu.
3. Highlight Sleep Timer by using “**^**” or “**v**” button.

4. Use “**<**” or “**>**” button to set. The timer can be programmed between **Off** and **2.00** hours (120 minutes) in steps of 30 minutes.

Setting Programme Timers

You can set programme timers for a particular programme using this feature.

1. While in Timers menu, press “**v**” button to activate timers functions.
2. Programme timer function buttons will be displayed on the screen.
3. Press **YELLOW** button on the remote control to add a timer. Timer options and definitions are as the following:

Network Type: This feature is unavailable to be set.

Timer Type: This feature is unavailable to be set.

Channel: Changes channel by using “**<**” or “**>**”.

Record Type: This item is unavailable to be set.

Date: Enter a date using the numeric buttons.

Start: Enter a starting time using the numeric buttons.

End: Enter an ending time using the numeric buttons.

Duration: Displays duration between the starting and ending time.

Repeat: Sets a timer to be repeated as Once, Daily or Weekly. Use “**<**” or “**>**” buttons to select an option.

Change/Delete: Sets the change/delete permission.

Playback: Sets the playback permission and parental settings.

4. Press **GREEN** button to save the timer. Press **RED** button to cancel.

Editing a Timer

1. Select the timer you want to edit by pressing “**^**” or “**v**” button.
2. Press “**GREEN**” button. Edit Timer menu screen will be displayed.
3. When finished with editing, press “**GREEN**” button to save. You can press “**MENU**” button to cancel.

Deleting a Timer

1. Select the timer you want to delete by pressing “**^**” or “**v**” button.
2. Press **RED** button.
3. Select **YES** by using “**<**” or “**>**” buttons to delete the timer. Select **NO** to cancel.

Basic Features

Picture Controls

Configuring Picture Settings

You can use different picture settings in detail.

Press “MENU” button and select the Picture icon by using “◀” or “▶” button. Press **OK** button to view Picture Settings menu.

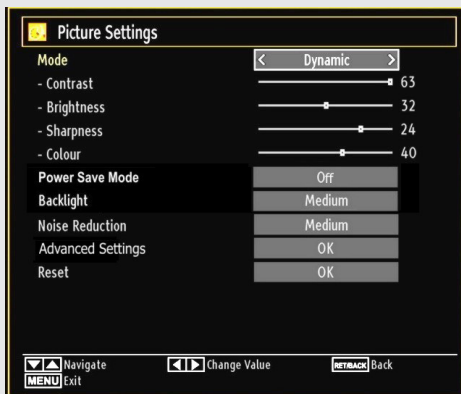

Operating Picture Settings Menu Items

Press “^” or “v” button to highlight a menu item.

Use “◀” or “▶” button to set an item.

Press “MENU” button to exit.

Picture Settings Menu Items

Mode: For your viewing requirements, you can set the related mode option. Picture mode can be set to one of these options: **Cinema, Game, Dynamic** and **Natural**.

Contrast: Sets the lightness and darkness values of the screen.

Brightness: Sets the brightness value for the screen.

Sharpness: Sets the sharpness value for the objects displayed on the screen.

Power Save Mode : Use “▼” or “▲” button to select Power Save Mode.

Press “◀” or “▶” button to set Power Save Mode as On or Off.

See the section, “Environmental Information” in this manual for further information on Power Save Mode.

NOTE: The backlight function will be inactive if Power Save Mode is set to on.

Backlight : This setting controls the backlight level and it can be set to Auto, Maximum, Minimum, Medium and Eco Mode (optional).

NOTE: Backlight can not be activate in VGA or Media Browser mode or while picture mode is set as Game.

Noise Reduction: If the broadcast signal is weak and the picture is noisy, use **Noise Reduction** setting to reduce the noise amount. Noise Reduction can be set to one of these options: **Low, Medium, High** or **Off**.

For normal colours, select **Normal** option.

Setting **Warm** option gives white colours a slight red stress.

• **Picture Zoom:** Sets the picture size to **Auto, 16:9, Subtitle, 14:9, 14:9 Zoom, 4:3** or **Cinema**.

• **HDMI True Black:** While watching from HDMI source, this feature will be visible in the Picture Settings menu. You can use this feature to enhance blackness in the picture. You can set this feature as “On” for activating HDMI True Black mode.

• **Film Mode (optional):** Films are recorded at a different number of frames per second to normal television programmes. Press “▼” or “▲” buttons to select Film mode. Press “◀” or “▶” buttons to set this feature Auto or Off. Turn this feature to Auto when you are watching films to see the fast motion scenes clearly.

• **Colour Shift:** Adjust the desired colour tone.

Reset: Resets the picture settings to factory default settings.

While in VGA (PC) mode, some items in Picture menu will be unavailable. Instead, VGA mode settings will be added to the Picture Settings while in PC mode.

PC Picture Settings Operation

For adjusting PC picture items, do the following:

Press “◀” or “▶” button to select Picture icon. Picture menu appears on the screen.

Contrast, Brightness, Colour, Colour Temp and Picture Zoom, Reset settings in this menu are identical to settings defined in TV picture settings menu. **Sound, Settings and Source settings are identical to the settings explained in the main menu system.**

PC Position: Select this to display PC position menu items.

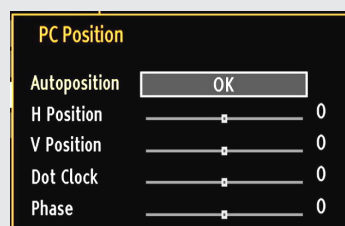

Autoposition: Automatically optimizes the display. Press **OK** to optimize.

H Position: This item shifts the image horizontally to right hand side or left hand side of the screen.

V Position: This item shifts the image vertically towards the top or bottom of the screen.

Dot Clock: Dot Clock adjustments correct the interference that appear as vertical banding in dot intensive presentations like spreadsheets or paragraphs or text in smaller fonts.

Phase: Depending on the resolution and scan frequency that you input to the TV set, you may see a hazy or noisy picture on the screen. In such a case you can use this item to get a clear picture by trial and error method.

Basic Features

Sound and Source Settings

Configuring Sound Settings

Sound settings can be configured according to your personal preferences.

Press “**MENU**” button and select the first icon by using “**<**” or “**>**” button. Press **OK** button to view Sound Settings menu.

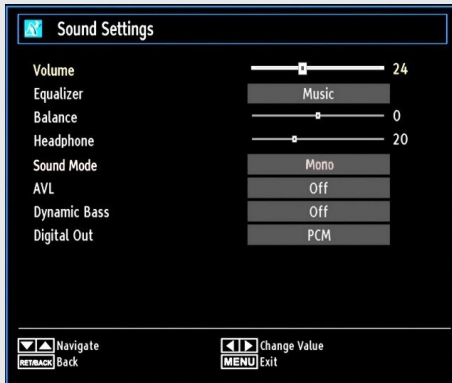

Operating Sound Settings Menu Items

Press “**^**” or “**v**” button to highlight a menu item.

Use “**<**” or “**>**” button to set an item.

Press “**MENU**” button to exit.

Sound Settings Menu Items

Volume: Adjusts volume level.

Equalizer: Press **OK** button to view equalizer sub-menu.

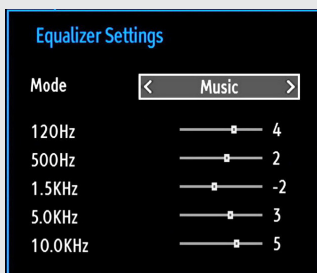

In the equalizer menu, the preset can be changed to **Music, Movie, Speech, Flat, Classic** and **User**. Press the “**MENU**” button to return to the previous menu.

NOTE: Equalizer menu settings can be changed manually only when the **Equalizer Mode** is in **User**.

Balance: This setting is used for emphasizing left or right speaker balance.

Headphone: Sets headphone volume.

Sound Mode: You can select Mono, Stereo, Dual I or Dual II mode, only if the selected channel supports that mode.

AVL: Automatic Volume Limiting (AVL) function sets the sound to obtain fixed output level between programmes (For instance, volume level of advertisements tend to be louder than programmes).

Dynamic Bass: Dynamic Bass is used to increase bass effect of the TV set.

Surround Mode: Surround mode can be change as On or Off.

Digital Out: Sets digital out audio type.

Configuring Source Settings

You can enables or disable selected source options. The TV will not switch to the disabled source options when “**SOURCE**” button is pressed.

Press “**MENU**” button and select Settings icon by using “**<**” or “**>**” button. Press **OK** button to view **Settings** menu. Select Source and press **OK** button.

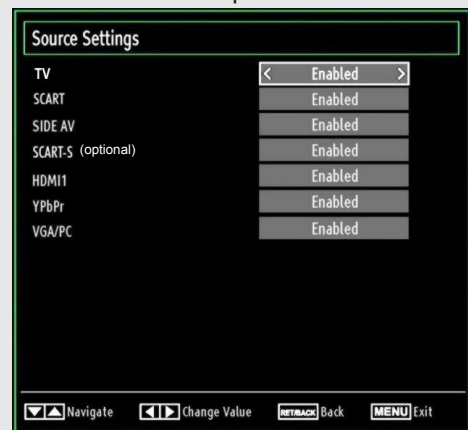

Select **Sources** in the Settings menu and press **OK** button.

Press “**<**” or “**>**” buttons to select a source.

Use “**<**” or “**>**” button to enable or disable the selected source. Changes are automatically stored.

Basic Features

Other Controls

To view general configuration preferences, select **Other Settings** in the Settings menu and press **OK** button.

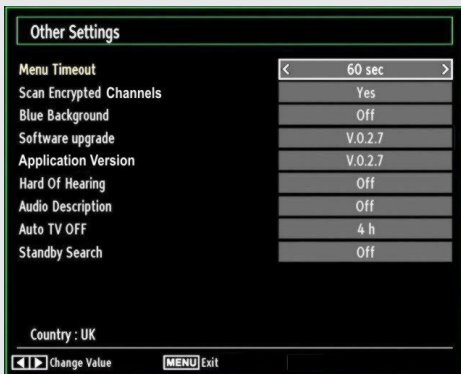

Operation

Press “ \wedge ” or “ \vee ” buttons to select an item.

Use “ \langle ” or “ \rangle ” button to set an option.

Press **OK** button to view a sub-menu.

Other Settings Menu Items

Menu Timeout: Changes timeout duration for menu screens.

Scan Encrypted Channels: When this setting is set as **YES**, search process will locate the encrypted channels as well. If it is set as **NO**, encrypted channels will not be located in automatic search or manual search.

Blue Background: Activates or deactivates blue background system when the signal is weak or absent.

Software Upgrade: To ensure that your TV always has the most update information, you can use this setting. In order for the proper operation, please ensure that the TV is set to standby mode.

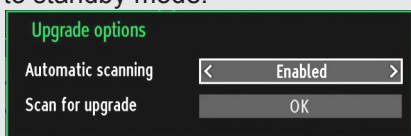

You can enable or disable automatic upgrade by setting **Automatic Scanning** option.

You can manually search for new software by selecting **Scan for upgrade**.

Application version: Displays the current application version.

Hard of Hearing: If the broadcaster enables any special signal concerning the audio, you can set this setting as On to receive such signals.

Application version: Displays the current application version.

Audio Description: Audio description refers to an additional narration track for blind and visually impaired viewers of visual media, including television and movies. The description narrator talks through the presentation, describing what is happening on the screen during the natural pauses in the audio (and sometimes during dialogue, if deemed necessary). You can use this feature, only if the broadcaster supports that additional narration track.

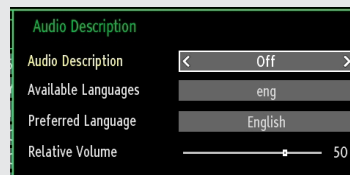

Auto TV Off: You can set the timeout value of auto off feature. After the timeout value is reached and the TV is not operated for selected time, the TV will go off.

Broadcast Type (optional): When you set the desired broadcast type by using “ \langle ” or “ \rangle ” button, the TV will display the related channel list. If the related source has does not include any stored channels, “No channels for this type have been found.” message will be displayed on the screen.

Standby Search (optional): Use “ \wedge ” or “ \vee ” button to select Standby Search and then press “ \langle ” or “ \rangle ” button to set this setting as On or Off. If you change Standby Search to Off, this function will be unavailable. To use Standby search please make sure that you select Standby Search as On.

Advanced Features

Media Browser

Only available when a USB device is plugged into the TV.

Starting Media Browser

1. Press **MENU** button on the remote control and select "**Media Browser**" pressing "**<**" or "**>**" button.
2. Press **OK** button to continue.
3. Use the "**^**" or "**v**" button to select a device and press OK. Media Browser menu contents (depending on the contents of your USB drive) will be displayed. You can play music, picture and video files from the connected USB memory stick.

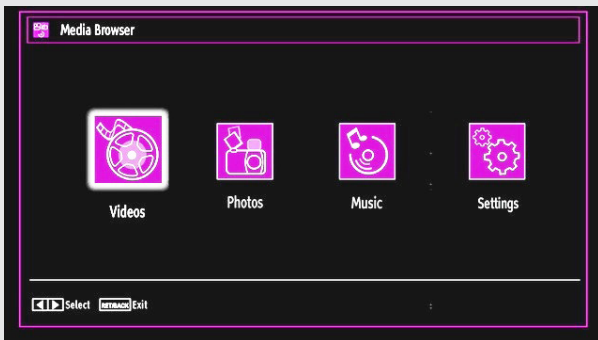

Media Browser Configuration

Select Settings icon from the main media browser page to view the current preferences.

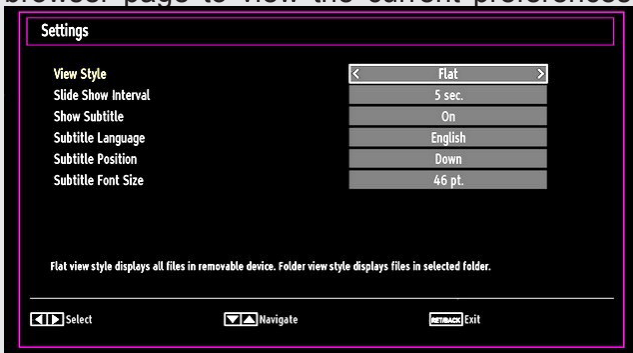

You can set your Media Browser preferences by using the Settings dialogue.

Operation

Press "**^**" or "**v**" button to highlight an item.
Use "**<**" or "**>**" button to configure an item.

View Style

Sets default browsing mode. Sets default browsing mode as folder or flat. Select "Directory" to display files in a folder or "Normal" to view files directly. If you select the view style "Directory" the menu point "All" will appear in the media browser (See the section: Media playback using media browser). The option "All" gives you an overview of the directories images, music, videos.

Slide Show Interval

Sets slide show interval time.

Show Subtitle

Sets subtitle enabling preference.

Subtitle Language

Sets supported subtitle language.

Subtitle Position

Sets subtitle position as up or down.

Subtitle Font Size

Sets subtitle font size (max. 54pt).

Loop / Shuffle during Playback

Press **BLUE** button once to disable Loop.

Press again to disable both Loop and Shuffle.

Press once more to enable only Loop.

Press again to enable all and again to deactivate all.

By the change of the symbols you can see which feature is enabled.

Advanced Features

Media Browser - continued

Viewing Videos via USB

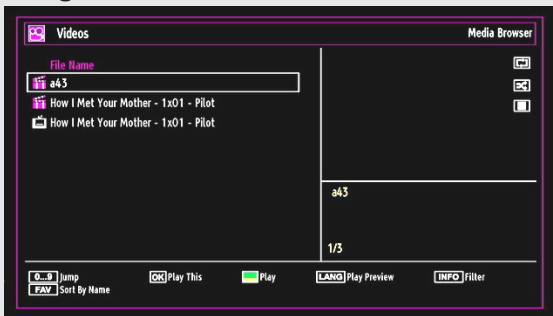

1. Select **Videos** from the **Media Browser** screen and press **OK** button.
2. All video files will be filtered and listed.
3. Use “▼” or “▲” button to select a video file and press **OK** button to play a video.

Follow the information on the operations bar for using other commands.

Video Playback Screen

The following screen will be displayed while playing a video file.

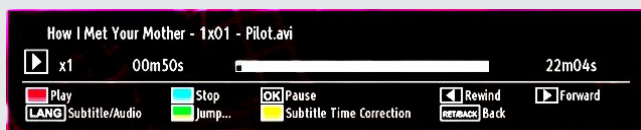

Subtitle Time Correction

Press **YELLOW** button during the video playback for activating **Subtitle Time Correction** screen.

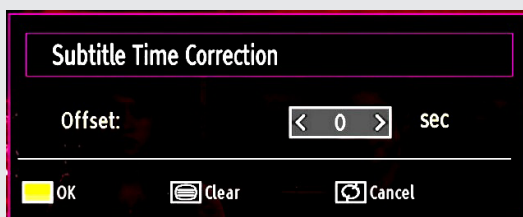

1. Enter an offset value using “◀” or “▶” button.
2. Press **YELLOW** button to confirm or press **RETURN** button to switch back to previous menu.

Viewing Photos via USB

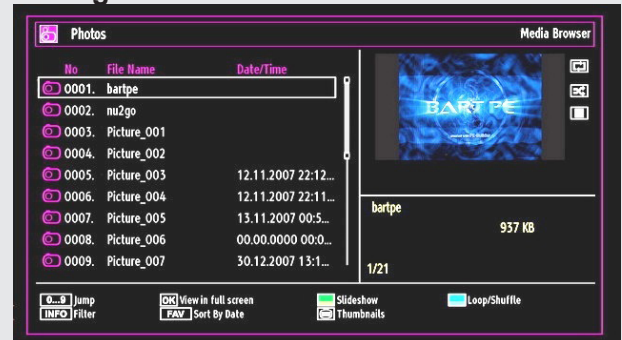

1. Select **Photos** from the **Media Browser** screen and press **OK** button.
2. All photo files will be filtered and listed.
3. Use “▼” or “▲” button to select a photo file and press **OK** button to play a video.

Follow the information on the operations bar for using other commands.

Displaying Photos in Slideshow Mode

1. Press **GREEN** button when viewing photo files to activate slideshow mode.

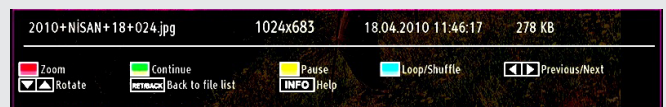

2. Press **RETURN** to go back to Photos screen.

Follow the information on the operations bar for using other commands.

Playing Music via USB

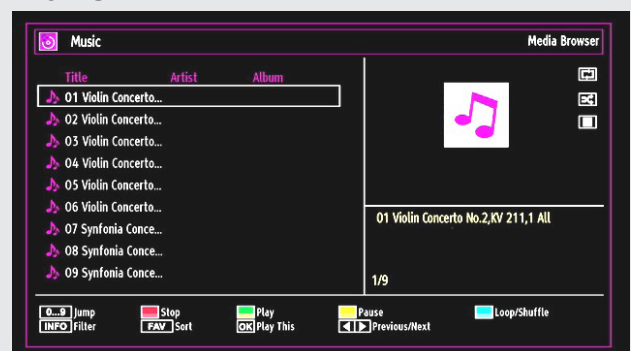

1. Select **Music** from the **Media Browser** screen and press **OK** button.
2. All music files will be filtered and listed.
3. Use “▼” or “▲” button to select a music file and press **OK** button to play.

Follow the information on the operations bar for using other commands.

Advanced Features

Setting the channels

Accessing Installation Menu

1. Press “**MENU**” button on the remote control and select **Installation** by using “**<**” or “**>**” button.
2. Press “**OK**” button and the **Installation** screen will be displayed.

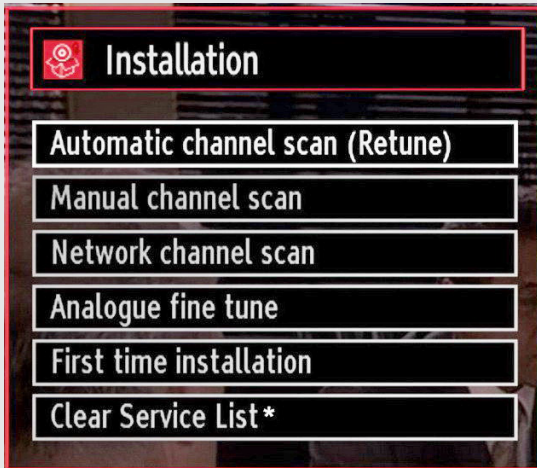

Automatic Channel Scan (Retune)

1. In the Installation menu, select “Automatic Channel Scan (Retune)” by using “**^**” or “**v**” button and press **OK** button.
2. Options will be displayed. You can select options by using “**^**” or “**v**” and **OK** buttons.

Menu Operations

Digital Aerial: Searches and stores aerial DVB stations.

Analogue: Searches and stores analogue stations.

Digital & Analogue: Searches and stores both analogue and aerial DVB stations.

3. Whenever you select an automatic search type and press **OK** button, a confirmation screen will appear on the screen. To start installation process, select **Yes**, to cancel select **No** by using “**<**” or “**>**” and “**OK**” button.

4. After auto channel scan type is set and selected and confirmed, installation process will start and progress bar will move along.

If desired, press “**MENU**” button to cancel process. In such a case, located channels are not stored.

Manual Channel Scan

1. In the Installation menu, select “Manual Channel Scan” by using “**^**” or “**v**” button and press **OK** button.
2. Manual Scan options screen will be displayed.

Select the desired “Search Type” using “**<**” or “**>**” button. Manual search options will change accordingly.

3. Enter the multiplex (for digital manual search) or frequency number (for analogue manual search) using the numeric buttons and press **OK** button to start search.

Analogue Fine Tune

1. Select “Analogue Fine Tune” from the Installation menu by using “**v**” or “**^**” and **OK** buttons. Analogue fine tune screen will be displayed.

 **NOTE:** Analogue Fine Tune feature will not be available if there are no analogue channels, digital channels and external sources stored.

2. Press **OK** button to proceed. Use “**◀**” or “**▶**” button to set Fine Tune. When finished, press **OK** button again.

First Time Installation

Deletes all stored channels and settings, resets TV to factory settings and starts first time installation.

1. Select **First Time Installation** option and press **OK** button if you would like to reset the TV.
2. A warning screen will be displayed. Select **YES** and press **OK** to continue. All prestored channels and settings will be deleted in such a case.
3. The TV will reset after a short time and language selection menu will be displayed.
4. Follow the steps in the **Initial set up** section.

Clear Service List

(*) This setting is visible only when the Country option is set to Denmark, Sweden, Norway or Finland.

1. Use this setting to clear channels stored. Press “**^**” or “**v**” button to select Clear Service List and then press **OK**.
2. An OSD message will be displayed on the screen. Press **OK** to cancel or select **Yes** to delete all of the stored channels.

Advanced Features

Parental Control

To prohibit viewing of certain programmes, channels and menus can be locked by using the parental control system. This function enables or disables the menu protection system and allows the PIN code to be changed.

1. Press “**MENU**” button and select the Settings icon by using “**<**” or “**>**” button.
2. Press OK button to view Settings menu. Use “**^**” or “**v**” button to highlight Parental and press “**OK**” to continue:



3. To display parental lock menu options, PIN number must be entered. Factory default PIN number is **0000**. After coding the correct PIN number, parental settings menu will be displayed:



Parental Settings Menu Operation & Items

- Select an item by using “**^**” or “**v**” button. Use “**<**” or “**>**” button to set an item.
- Press **OK** button to view more options.

Menu Lock: Menu lock setting enables or disables the menu access. You can disable access to the installation menu or the whole menu system.

Maturity Lock (not available for the UK): When set, this option gets the maturity information from the broadcast and if this maturity level is disabled, disables access to the broadcast.

Child Lock (optional): When Child Lock is set, the TV can only be controlled by the remote control. In this case the control panel buttons will not work, except for the Standby Off/On button. When Child Lock is activated you are able to switch the TV into Standby mode with the Standby Off/On button. To switch the TV on again, you need the remote control. Hence, if one of those buttons is pressed, **Child Lock Is On** will be displayed on the screen when the menu screen is not visible.

Set PIN: Defines a new PIN number. Use numeric buttons to enter a new pin number. You will need to code your new pin a second time for verification purposes.

IMPORTANT: The factory default pin number is **0000**, if you change the pin number make sure you write it down and keep it safe.

Other Information

Teletext

Analogue Teletext

Teletext system transmits information such as news, sports and weather on your TV. Note that if the signal degrades, for example in poor/adverse weather conditions, some text errors may occur or the teletext mode may be aborted.

Analogue Teletext

Teletext function buttons are listed below:

“” **Teletext / Mix** : Activates teletext mode when pressed once. Press again to place the teletext screen over the programme (mix). Pressing again will quit the teletext mode.

“**RETURN**” **Index**: Selects the teletext index page.

“**INFO**” **Reveal**: Shows hidden information (e.g. solutions of games).

“**OK**” **Hold**: Holds a text page when convenient. Press again to resume.

“ < ” or “ > ” **Subcode Pages** : Selects subcode pages if available when the teletext is activated.

P+ / P- and numbers (0-9): Press to select a page.

Note: Most TV stations use code 100 for their index pages.

Coloured Buttons

(RED/GREEN/YELLOW/BLUE)

Your TV supports both **FASTTEXT** and **TOP text** systems. When these systems are available, the pages are divided into groups or topics. When **FASTTEXT** system is available, sections in a teletext page will become colour-coded and can be selected by pressing the coloured buttons. Press a coloured button that corresponds to with your needs. The coloured writings will appear, showing you which coloured buttons to use when **TOP text** transmission is present. Pressing “**^**” or “**∨**” commands will request the next or previous page respectively.

Digital Teletext (for the UK only)

1. Press the “” button. The digital teletext information appears on screen.

2. Operate using the coloured buttons, cursor buttons and **OK** button.

The operation method may differ depending on the contents of the digital teletext.

3. Follow the instructions displayed on digital teletext screen.

When “Press **SELECT** button” or similar message appears on the screen, press **OK** button.

When the “” button is pressed, the TV returns to television broadcasting.

When you press the “” button again, the digital teletext screen will be displayed.

Other Information

Specifications

TV Broadcasting	PAL/SECAM B/G D/K K' I/I' L/L'
Receiving Channels	VHF (BAND I/III) - UHF (BAND U) - HYPERBAND
Number of Preset Channels	1000
Channel Indicator	On Screen Display
RF Aerial Input	75 Ohm (unbalanced)
Operating Voltage	220-240V AC, 50Hz.
Audio	German+Nicam Stereo
Audio Output Power (W_{RMS}) (10% THD)	2 x 2,5
Power Consumption	45 W
Weight	3,35
TV Dimensions DxLxH (with foot)	118 x 459 x 344
TV Dimensions DxLxH (without foot)	39 x 459 x 312
VESA	75 x 75 mm / M4
Display	16:9 display, 48 cm / 19" Screen Size 1366X768 max. resolution
Digital Reception (MPEG-4)	
MHEG-5 ENGINE compliant with ISO/IEC 13522-5 UK engine Profile 1 - for UK	
Object carousel support compliant with ISO/IEC 135818-6 and UK DTT profile - for UK	
Frequency range: 474-850 MHz for UK models	
170-862 MHz for EU models	
Transmission standard: MPEG-4	
Demodulation: COFDM with 2K/8K FFT mode	
FEC: all DVB models	
Video: MP@ML, PAL, 4:3/16:9	
Audio: MPEG Layer I&II 32/44.148kHz.	
We apologise for any inconvenience caused by any minor inconsistencies in these instructions, which may occur as a result of product improvements and development.	

Other Information

Plug replacement - UK and Ireland only

Should you need to replace the plug; the wires in the power cable are coloured in the following way:

Blue – Neutral 'N'

Brown – Live 'L'

Green & Yellow – Earth 'E'

As the colours of the wires in the power cable may not correspond with the coloured markings identifying the terminals in your plug, and proceed as follows:

The green & yellow wire must be connected to the terminal in the plug that is marked with the letter E or by the earth symbol.

The blue wire must be connected to the terminal that is marked with the letter N.

The brown wire must be connected to the terminal that is marked with the letter L.

If the power lead is damaged, it must be replaced by a qualified electrician.

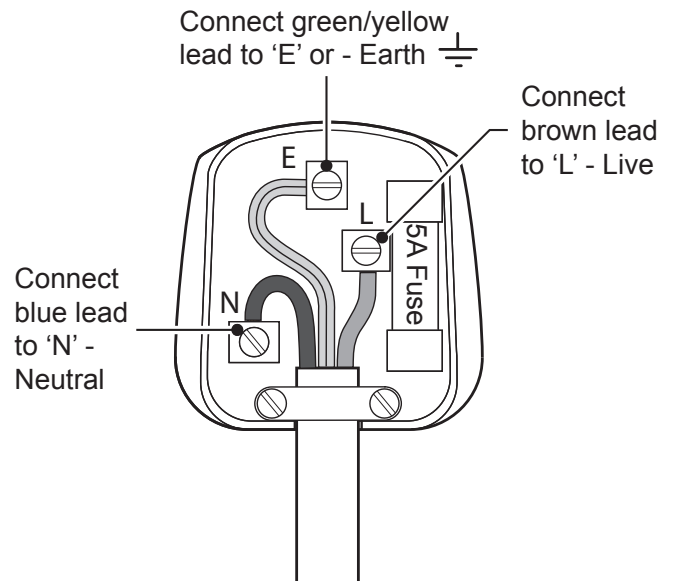

Other Information

The Argos Technical Helpline is here to help

Technical experts are available 7 days a week

- **Simple help and advice on setting up your digital equipment (image).**
- **Guidance on connecting other devices to your television such as a DVD player, Sky, home cinema system or a games console.**
- **Order spare parts, including that lost remote control.**
- **Any other technical issues you may need assistance with.**

Call us today: 0044 845 604 0105

Local call rates applies*

Lines open 9am-8pm Monday to Saturday and 10am-4pm Sunday.

*Calls to Argos enquiry lines may attract a charge and set up fee from residential lines depending on your call plan/tariff. Mobile and other providers costs may vary, see www.bt.com/pricing for details.

For Security and training purposes, telephone calls to and from customer service centres maybe recorded and monitored. Calls from Republic of Ireland will attract international call charges.

Product Support

Trouble shooting

Image persistence - ghosting

Please note that ghosting may occur while displaying a persistent image (still or paused image). LCD TVs' image persistence may disappear after a short time. Try turning off the TV for a while. To avoid this, do not leave the screen in still picture mode for extended periods.

No power

If your TV has no power, please check the power cord plug is connect to the mains power socket.

Poor picture

1. Have you selected the correct TV system?
2. Is your TV or house aerial located too close to a non-earthed audio equipment or neon lights, etc.?
3. Mountains or high buildings can cause double pictures or ghost images. Sometimes you can improve the picture quality by changing the direction of the aerial. Is the picture or teletext unrecognisable?
4. Check if you have entered the correct frequency.
5. Please retune the channels.
6. The picture quality may degrade when two devices are connected to the TV at the same time. In such a case, disconnect one of the devices.

No picture

1. No Picture means that your TV is not receiving a transmission. Have you selected the correct button on the remote control? Try once more. Also make sure the correct input source has been selected.
2. Is the aerial connected properly?
3. Are the plugs connected tightly to the aerial socket?
4. Is the aerial cable damaged?
5. Are suitable plugs used to connect the aerial?
6. If you are in doubt, consult your dealer.

No sound

1. Has the TV been set to mute? To cancel mute, press the "M" button, or increase the volume level.
2. Sound is coming from only one speaker. Is the balance set to one extreme? See Sound Menu section.

Remote control - does not operate

Your TV no longer responds to the remote control. The batteries may be exhausted, if so you can still use the control buttons on the left side of the TV. (* Is only possible if they are not blocked by parental control.)

Input sources - can not be selected

1. If you cannot select an input source, it is possible that no device is connected.
2. Check the AV cables and connections if you have tried to connect a device.

If nothing works..

If you have tried the above solutions and none seem to work, try switching your TV off and on again. If this does not work, contact your supplier or TV repair technician. Never attempt to repair a defective TV yourself.

Product Support

Disposal information

Instructions for waste disposal:

Packaging and packaging aids are recyclable and should principally be recycled. Packaging materials, such as foil bag, must be kept away from children.

The cold cathode fluorescent lamp in LCD PANEL contains a small amount of mercury; please follow the local laws or regulations for disposal.

Information for Users on Disposal of old Equipment and Batteries (European Union only)

These symbols indicate that equipment with these symbols should not be disposed of as general household waste. If you want to dispose of the product or battery, please consider the collection systems or facilities for appropriate recycling.

Notice: The sign Pb below the symbol for batteries indicates that this battery contains lead.

Information for Users in European Union Countries

This symbol on the product or on its packaging means that your electrical and electronic device should be disposed of at the end of its service life separately from your household wastes. There are separate collection systems for recycling in EU.

For more information, please contact the local authority or the dealer where you purchased the product.



Products



Battery



Supported DVI Resolutions

When connecting devices to your TV's connectors by using DVI converter cables (not supplied), you can refer to the following resolution information.

Index	Resolution	Frequency
1	640x400	70Hz
2	640x480	60Hz-66Hz-72Hz -75Hz
3	800x600	56Hz-60Hz-70Hz-72Hz -75Hz
4	832x624	75 Hz
5	1024x768	60Hz-66Hz-70Hz-72Hz -75Hz
6	1152x864	60Hz-70Hz-75Hz
7	1152x870	75Hz
8	1280x768	60 HzA
9	1280x768	60 HzB
10	1280x768	75Hz
11	1280x960	60Hz-75Hz
12	1280x1024	60Hz-75Hz
13	1360x768	60 Hz
14	1400x1050	60 HzA
15	1400x1050	60 HzB
16	1400x1050	75Hz
17	1400x900	65Hz-75Hz
18	1600x1200	60 Hz
19	1680x1050	60 Hz
20	1920x1080	60 HzA
21	1920x1080	60 HzB
22	1920x1200	60HzA
23	1920x1200	60Hz
24	480i-480p	60Hz
25	576i-576p	50Hz

Product Support

Supported File Formats for USB Mode

Media	File		Format		Remarks (Maximum resolution/Bit rate etc.)
	Extension	Video	Audio		
Movie	.mpg, .mpeg	MPEG1, 2	MPEG Layer 1/2/3		MAX 1920x1080 @ 30P 20Mbit/sec
	.dat	MPEG1, 2	MPEG2		
	.vob	MPEG2			
	.mkv	H.264, MPEG1,2,4	EAC3 / AC3		
	.mp4	MPEG4, Xvid 1.00, Xvid 1.01, Xvid 1.02, Xvid 1.03, Xvid 1.10- beta1/2 H.264	PCM/MP3		
Movie	.avi	MPEG2, MPEG4	PCM/MP3		MAX 1920x1080 @ 30P 20Mbit/sec
		Xvid 1.00, Xvid 1.01, Xvid 1.02, Xvid 1.03, Xvid 1.10-beta1/2 H.264	PCM		
Music	.mp3	-	MPEG 1 Layer 1 / 2 (MP3)		32Kbps ~ 320Kbps(Bit rate) 32KHz ~ 48KHz(Sampling rate)
Photo	.jpg .jpeg	Baseline JPEG		max WxH = 15360x8640	4147200bytes
		Progressive JPEG		max WxH = 1024x768	6291456bytes
	.bmp	-		max WxH = 9600x6400	3840000bytes
Subtitle	.sub	-		-	
	.srt	-		-	

AV and HDMI Signal Compatibility (Input Signal Types)

Source	Supported Signals		Available	
EXT (SCART)	PAL 50/60		O	
	NTSC 60		O	
	RGB 50		O	
	RGB 60		O	
Side AV	PAL 50/60		O	
	NTSC 60		O	
YPbPr	480I	60Hz	O	
	480P	60Hz	O	
	576I	50Hz	O	
	576P	50Hz	O	
	720P	50Hz	O	
	720P	60Hz	O	
	1080I	50Hz	O	
	1080I	60Hz	O	
	1080P	50Hz	O	
	1080P	60Hz	O	
	HDMI	480I	60Hz	O
		480P	60Hz	O
576I		50Hz	O	
576P		50Hz	O	
720P		50Hz	O	
720P		60Hz	O	
1080I		50Hz	O	
1080I		60Hz	O	
1080P		50Hz	O	
1080P		24Hz	O	

(X: Not Available, O: Available)

In some cases a signal on the LCD TV may not be displayed properly. The problem may be an inconsistency with standards from the source equipment (DVD, Set-top box, etc.). If you do experience such a problem please contact your dealer and also the manufacturer of the source equipment.

Product Support

PC Input Typical Display Modes

The display has a maximum resolution of 1920 x 1200. The following table is an illustration of some of the typical video display modes. Your TV may not support different resolutions. Supported resolution modes are listed below. If you switch your PC to an unsupported mode, a warning OSD will appear on the screen.

Index	Resolution	Frequency
1	640x350	85 Hz
2	640x400	70 Hz
3	640x480	60Hz-66Hz-72Hz -75Hz-85Hz
4	800x600	56Hz-60Hz-70Hz-72Hz -75Hz-85Hz
5	832x624	75 Hz
6	1024x768	60Hz-66Hz-70Hz-72Hz -75Hz
7	1152x864	60Hz-70Hz-75Hz -85 Hz
8	1280x768	60 HzA
9	1280x768	60 HzB
10	1280x768	75Hz-85Hz
11	1280x960	60Hz-75Hz-85Hz
12	1280x1024	60Hz-75Hz-85Hz
13	1360x768	60 Hz
14	1400x1050	60 HzA
15	1400x1050	60 HzB
16	1400x1050	75Hz-85Hz
17	1400x900	65Hz-75Hz
18	1600x1200	60 Hz
19	1680x1050	60 Hz
20	1920x1080	60 HzA
21	1920x1080	60 HzB
22	1920x1200	60HzA
23	1920x1200	60Hz

Product Support

Definition of important terms - TV

Aspect Ratio

This refers to the ratio of the width to the height of a picture.

AVL

Automatic volume limiter.

Brightness

This defines the overall light level of the entire image.

Contrast

This will adjust the range of optical density and tone of the complete picture.

Component Audio Inputs

Used for the standard analog audio for interconnection of components.

Component Video Inputs (Y/Pb/Pr)

This video signal consist of colour differences and a luminance signal.

DTV

Digital television broadcasts.

HDMI

High Definition Multimedia Interface. This connection provides high-quality, uncompressed digital video and audio, combining both audio and video signals via a single connection.

Multichannel audio

Means that the TV program is aired in several audio versions, for example, in two different languages. This is possible if on an analogue TV each of the two channels of the stereo tracks for left and right channels are occupied with one audio track in mono (single channel). In digital TV multiple audio streams can be broadcasted and selected on the receiver side

NTSC

United States' standard for scanning television signals that has been adopted by some other countries.

LCN

LCN is the Logical Channel Number system that organizes available broadcasts in accordance with a recognizable channel sequence.

OSD

On Screen Display. Information, like channel number and volume on the screen of a TV.

PAL

The European TV standard for scanning television signals.

Scart

A 21-pin audio/video connector found primarily on European televisions.

SECAM

The video format used in France and some other countries, similar to PAL.

Sharpness

A control that creates the effect of greater resolution by light to dark transitions.

System

Defines the broadcast type of the TV picture since these broadcast systems are not same for all countries.

VGA

VGA is a common standard graphics display system for PCs.

Software Upgrade

Your TV is capable of finding and updating new software upgrades over broadcast channels.

For broadcast channels search, TV looks the available channels stored in your settings. So before software upgrade search, it is advised to auto search and update all available channels.

1) Software upgrade search via user interface

It is possible manually to check if there is a new software upgrade for your TV set.

Simply navigate on your main menu. Choose Settings and select Other Settings menu. In Other Settings menu navigate on to the Software Upgrade item and press OK button to open Upgrade Options menu.

In Upgrade Options menu select Scan for upgrade and press OK button.

If a new upgrade is found, it starts to download the upgrade. A progress bar indicates the remaining download progress. When download completes with success a message is displayed for reboot to activate new software. Press OK to continue with the reboot operation.

2) 3.AM search and upgrade mode

If Automatic scanning in Upgrade Options menu is enabled, TV wakes up at 03:00 and searches broadcast channels for new software upgrade. If new software is found and downloaded successfully, with next power up TV opens with new software version.

Note on reboot operation: Reboot is the last step in software upgrade operation if download of new software is finished successfully. During reboot TV makes final initializations. In reboot sequence panel power is closed and front led indicates the activity with blinking. Around 5 minutes later TV restarts with new software activated.

If your TV fails to restart in 10 minutes, unplug power for 10 minutes and re-plug again. TV should open with new software safely. If you still can not get TV working, please kindly repeat unplug and plug sequence a few times more. If your set still can not operate, please call the service personnel to fix the problem for you.

⚠ CAUTION: While led is blinking during reboot do not unplug your TV's power. Doing this may cause your TV not to re-open again and can only be fixed by service personnel.

✎ NOTE: A software update is dependent on whether the TV stations of each country support it.



Product Guarantee

This product is guaranteed against manufacturing defects for a period of



This product is guaranteed for twelve months from the date of original purchase. Any defect that arises due to faulty materials or workmanship will either be replaced, refunded or repaired free of charge where possible during this period by the dealer from whom you purchased the unit.

The guarantee is subject to the following provisions:

- The guarantee does not cover accidental damage, misuse, cabinet parts, knobs or consumable items.
- The product must be correctly installed and operated in accordance with the instructions contained in this manual.
- It must be used solely for domestic purpose.
- The guarantee will be rendered invalid if the product is re-sold or has been damaged by inexpert repair.
- Specifications are subject to change without notice.
- The manufacturer disclaims any liability for the incidental or consequential damages.
- The guarantee is in addition to, and does not diminish your statutory or legal rights.
- In the event of a problem with the product within the guarantee period call the **Customer Helpline: 0044 845 604 0105**.

Guarantor: Argos Ltd
489 - 499 Avebury Boulevard
Central Milton Keynes
MK9 2NW

